

# WIRE THREAD INSERTS



for internal thread strength



## Benefits and Applications

*For many years, helically coiled wire thread inserts have been vastly underestimated. The popular misconception that they were designed for the repair of damaged threads, has given this unique fastener a false image.*

Manufactured to exacting limits, from high quality aircraft material, they have been used successfully in many applications, ranging from supersonic aircraft and space exploration to simple children's toys. Because of their unique mechanical performance they have, like all good designs, hardly changed since their introduction in the early 1950's.

They are much lighter and less expensive than any other equivalent type of thread insert and because of their compact size, can generally be introduced into existing designs where no previous provision has been made.

In the following paragraphs we highlight some of the often overlooked realities of this simple but very special product.

### Strength

Due to their flexibility, wire thread inserts create internal threads which have a much improved distribution of residual stress loading when compared with conventional tapped holes, where up to 70% of the shearing forces are carried by the first three threads in the tapped hole. The flexibility of wire thread inserts helps to compensate for pitch and flank angle errors, inherent in normal tapped holes, and significantly enhances the load bearing capacity by deflecting the residual forces into a helical hoop stress which is dispersed into the wall of the tapped hole. This enables the design to be confidently based on the bolt strength utilising smaller and shorter threads even when used in low strength materials.

### Corrosion Resistance

WTI inserts are manufactured in 18/8 austenitic chromium/nickel stainless steel and offer excellent corrosion resistance, preventing adverse seizing and galling even at elevated temperatures. For applications involving severe corrosive conditions or subject to the effects of galvanic corrosion, a wide variety of surface coatings such as zinc, silver, cadmium or molybdenum disulphide are available.

### Temperature Range

Standard inserts, manufactured in 18/8 stainless steel are suitable for operation within temperatures ranging from -160°C to +420°C (-320°F to + 800°F). For applications involving extreme and elevated temperatures wire thread inserts can be manufactured in creep resistant nickel based alloys.

### Cost & Weight Benefits

Wire thread inserts are much lighter and less expensive than any other equivalent thread insert. As a result of their compact size they can generally be incorporated into existing designs where no previous provision has been made. In many instances, because of their mechanical strength benefits, their introduction may result in the use of thinner sections or lighter parent materials without sacrificing thread strength.

### Wear Resistance

Due to a combination of material hardness and brilliant surface finish wire thread inserts create internal threads in which wear due to thread friction is virtually eliminated. This is of particular value in applications requiring repeated assembly & disassembly. The low frictional coefficient ensures that virtually all of the applied assembly torque is converted into clamping load thus providing threads that stay tight.

## Introduction

*WTI Fasteners was formed in 1989, and has built a strong reputation as a manufacturer of high quality products, with a firm commitment to providing excellent customer service.*

We carry vast stocks of product in a wide variety of thread forms together with the associated taps and tooling. Our technical staff, have the knowledge and experience to offer support and advice from initial design to final installation.

Not just for repairs! – Wire thread inserts from WTI Fasteners provide the internal thread strength in weaker parent materials.

Precision engineered in the UK from high quality chromium nickel stainless steel - WTI can manufacture to all national and international standards including military and NATO stock numbers and are BS EN ISO 9001 registered.

They are available in two basic forms, free running or screw locking.

### Free Running

Produced from precision profiled austenitic stainless steel wire wound into a helical spiral, WTI free running inserts have a spring like appearance. When installed, using any one of a variety of manual or automatic tools, they provide strong permanent internal threads which resist heat and corrosion. Once fitted, their position is maintained by the action of radial pressure between their coils and the flanks of the tapped hole. This pressure exists because their free diameter is larger, by a calculated amount, than their installed diameter.

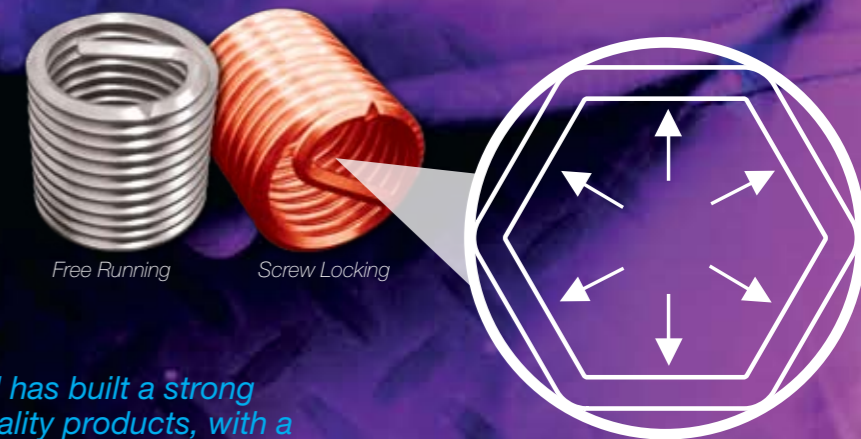

Screw Locking Mechanism

### Screw Locking

Screw locking (or prevailing torque) inserts are of particular value in applications subject to the effects of cyclic vibration or impact. In addition to the benefits afforded by free running inserts, WTI screw locking inserts offer the additional security of prevailing locking torque. This is achieved by the action of one or more polygonal grip coils positioned within the insert's length, which exert radial pressure on the male thread. Each grip coil consists of a number of tangential locking chords which protrude inside the minor diameter of the normal free running coils. As the male thread passes through these grip coils, the locking flats are displaced thus exerting radial pressure or prevailing torque on the male thread. On removal of the male thread, the locking coils relax to their original form permitting repeated assembly whilst retaining a measurable level of prevailing torque.

*Note: It is recommended that only close fit plated or lubricated bolts or screws are used with screw locking inserts.*



## Introduction

# Product Range

## Inserts

- Stainless Steel 304/316
- Inconel or Nimonic
- Phosphor Bronze
- Natural Finish
- Cadmium or Silver Electro Plate
- I.V.D. Aluminium Coating
- Dry Film Lubricant Coating
- Special sizes / thread forms available on request

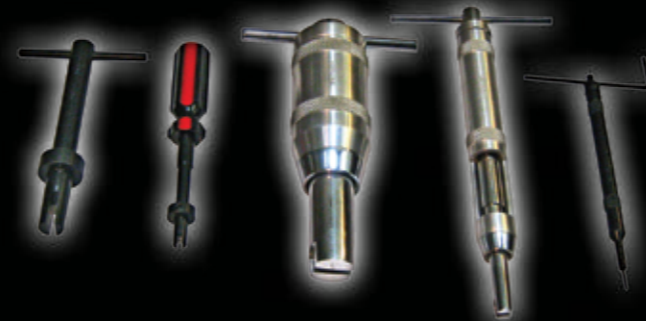

## Inserting Tools

- Prewind or Screwdriver types
- Plain or Threaded Mandrels

## Thread Repair Kits

- Pre-wind Tool Repair Kits
- Screwdriver Type Repair Kits
- Multi Size Repair Kits



## Tang Break Punches

Manual or Automatic Types

## Power Inserting Tools

- Electric or Pneumatic
- Fully Automatic or Semi-Automatic reversing



## Extractors

For Removal of Incorrectly Installed insert

## Gauges

Go/Not Go Tapped Hole and Fitted Insert Thread Plug Gauges



## Wire Insert Nuts

WTI Wire Insert Nuts provide high performance stainless steel free running or prevailing torque threads in a wide variety of malleable or lightweight nut blanks.



## Tape Feed Inserts

WTI Tape Feed Inserts, used in conjunction with pneumatic pre-wind tools, provide an efficient method of installation in certain high volume applications.



Product Range

Product Range

## Installation Procedure

### Stage 1 – Drill

Drill hole or drill out damaged thread.

### Stage 2 – Tap

Tap thread using wire thread insert tap.

### Stage 3 – Check

Check tapped hole using WTI tapped hole gauge.

### Stage 4 – Install

Place insert onto insertion tool. Where fitted adjust collar so the insert tang is centered in the slot. Position squarely and using very light downward pressure wind insert into hole until ½ turn below the surface.

DO NOT USE TOOL TO TWIST TANG OFF

### Stage 5 – Tang Break

Use tang break tool, where supplied, or lift tool from tang turn 90°, sit back on tang and give a sharp blow with a hammer.

For fine thread inserts use long nose pliers to PULL tang out.

### Stage 6 – Check

Check installed insert using thread plug gauge.

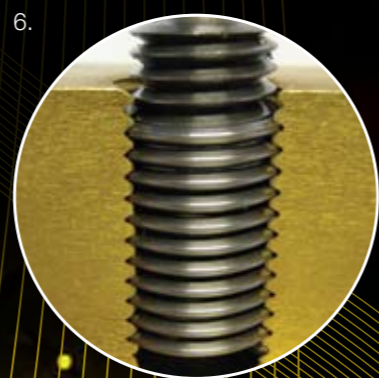
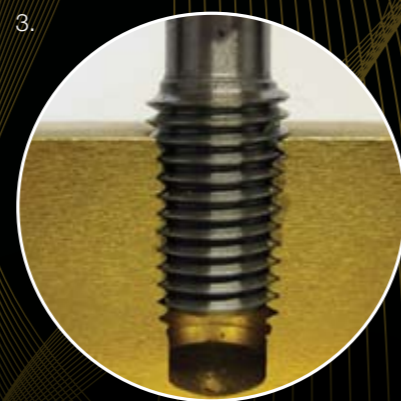

## Insert Materials & Finishes

WTI Standard inserts are manufactured from fully certified, aircraft quality, 18/8 austenitic stainless steel in accordance with BS EN 2947/DTD 734A (equivalent specifications SAE AS 7245, W.NR.1.4301). This material yields a high degree of toughness and hardness and is highly resistant to corrosion. It is suitable for operation in temperatures ranging from -160°C to +420°C withstanding surges of up to 500°C. Alternative materials including 316 stainless steel, plus a variety of additional surface coatings are available to suit a multitude of service conditions.

### Alternative Materials

**Phosphor Bronze** : Non ferrous copper/tin alloy in accordance with BS EN 12166. This material possesses a very low coefficient of friction and excellent resistance to corrosion fatigue. It is suitable for operation in temperatures ranging from -200°C to +300°C.

**Inconel X-750** : Heat resisting precipitation hardenable nickel base alloy in accordance with DIN EN 3018 (equivalent specifications SAE AS 7246, W.NR.2.4669). This material possesses good creep rupture strength and corrosion resistance at high temperatures. Its lack of cobalt makes it ideal for use in nuclear reactors. Inconel X-750 is suitable for operation in temperatures ranging from -200°C to +550° C.

**Nimonic 90** : Heat resisting precipitation hardenable nickel base alloy in accordance with BS2 HR 501 (equivalent specifications W.NR. 2.4632, UNS N07090). This material possesses greater creep rupture strength and corrosion resistance than Inconel X-750. Nimonic 90 is suitable for operation in temperatures ranging from -100°C to +650°C.

### Alternative Finishes & Coatings

**Cadmium Plate** : Electro-deposited Cadmium in accordance with Def Stan 03-19 (equivalent specifications SAE. QQ-P-416, LN 9368). Cadmium plating provides an excellent barrier between dissimilar metals dramatically reducing the effects of galvanic corrosion, its high lubricity and excellent corrosion resistance prevents seizure and galling between threaded components. Cadmium is unaffected by alkalis and withstands marine conditions far better than zinc. However, because of its toxic nature, the use of Cadmium plate is limited to the electrical and aerospace industries. Cadmium plate is suitable for operation in temperatures ranging from -200°C to +235°C.

**Zinc Plate** : Electro-deposited zinc in accordance with Def Stan 03-20/BS 7371-12. Zinc is the most widely applied electroplated finish in industry. It provides properties similar to cadmium at a much lower cost. Zinc is suitable for operation in temperatures ranging from -200°C to +250°C.

**Silver Plate** : Electro-deposited silver in accordance with BS EN 2786 (equivalent specifications ASTM B 700, EN 2786). Silver plating is used to prevent seizure and galling between thread components in high temperature applications and is most commonly applied to aero-engine fasteners. Silver plate is suitable for operation in temperatures ranging from -200°C to +650°C.

**Vac Cad** : Vacuum deposited cadmium plate in accordance with Def Stan. 03-28 pt. 2 (equivalent specification SAE AMS-C-8837). Vac Cad has found a niche in the aerospace industry replacing conventional electro-deposited cadmium on components where the risk of hydrogen embrittlement is un-acceptable. Vac cad is suitable for operation in temperatures ranging from -200°C to +235°C.

**IVD Aluminium** : Ion vacuum deposited pure aluminium coating in accordance with Def Stan. 03/28 (equivalent specification MIL-DTL-83488). Originally developed by McDonald Douglas, IVD Aluminium is already widely used in the aerospace industry where it is expected to eventually replace cadmium. Because it is vacuum deposited, the technical limitations associated with conventional electro-plating such as hydrogen embrittlement are eliminated. IVD aluminium provides corrosion resistance superior to cadmium in most applications. Its film thickness is uniform and the process is non toxic. IVD aluminium is suitable for operation in temperatures ranging from -200°C to +500°C.

**Dry Film Lubricant** : Solid film heat cured molybdenum disulphide dry film lubricant coating in accordance with SAE AS5272 provides a low frictional coefficient coating with excellent load bearing capabilities. Dry film lubricant prevents seizing and galling between threaded components and is particularly effective in screw locking insert applications. Dry film lubricant is suitable for operation in temperatures ranging from -100°C to +250°C.

**P.T.F.E.** : Solid film heat cured P.T.F.E. dry film lubricant coating provides a lower frictional coefficient than molybdenum disulphide and is available in a range of colours. As for molybdenum disulphide, P.T.F.E. dry film lubricant prevents seizing and galling between threaded components and is particularly effective in screw locking insert applications. P.T.F.E. coating is suitable for operation in temperatures ranging from -100°C to + 250°C.

# ISO Metric

## Threads to:-

- |            |                |
|------------|----------------|
| BS 3643    | LN 29580       |
| BS A 358-1 | LN 9163-1      |
| DIN 13-1   | ASME B1.13M    |
| ISO 965-1  | ASME B1.21M    |
| ISO 5855-1 | SAE MA 1370    |
|            | FED-STD-H28/21 |

Free diameter values and number of free coils are for guidance purposes only.

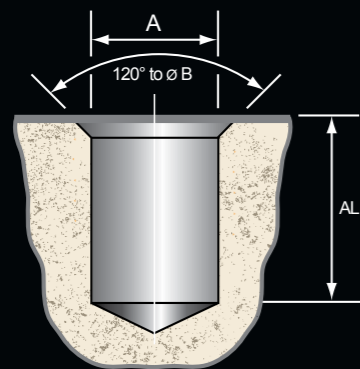

**DRILLED HOLE**  
See Note 1 opposite

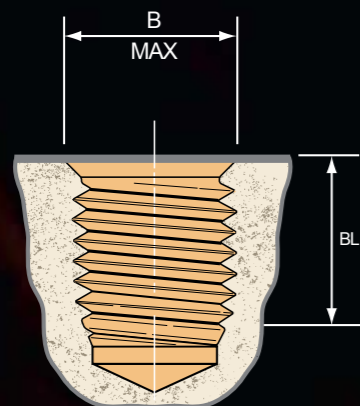

**TAPPED HOLE**  
See Note 2 opposite

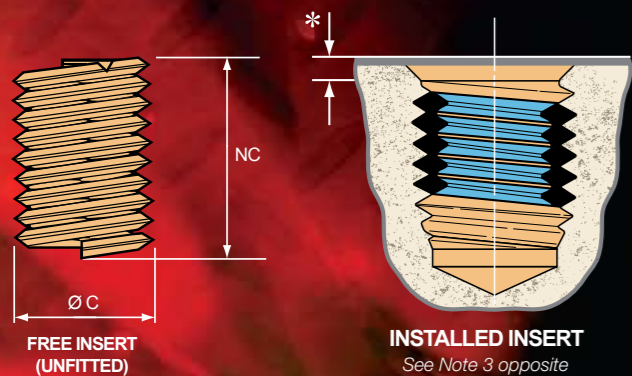

**INSTALLED INSERT**  
See Note 3 opposite

SIZE	Drill (A)	B	Free Coil ØC
mm	mm	mm	mm
M2 X 0.40	2.10	2.52 - 2.61	2.48 - 2.70
M2.5 X 0.45	2.60	3.08 - 3.18	3.04 - 3.70
M3 X 0.50	3.20	3.65 - 3.76	3.60 - 4.35
M3.5 X 0.60	3.70	4.28 - 4.41	4.22 - 4.95
M4 x 0.70	4.20	4.90 - 5.06	4.83 - 5.60
M5 X 0.80	5.20	6.04 - 6.21	5.94 - 6.80
M6 X 1.00	6.30	7.30 - 7.51	7.17 - 7.95
M7 X 1.00	7.30	8.30 - 8.51	8.17 - 9.20
M8 X 1.25	8.30	9.62 - 9.89	9.45 - 10.35
M8 X 1.00	8.30	9.30 - 9.51	9.17 - 10.25
M9 X 1.25	9.40	10.62 - 10.89	10.45 - 11.16
M9 x 1.00	9.30	10.30 - 10.51	10.17 - 11.23
M10 X 1.50	10.40	11.95 - 12.27	11.74 - 12.50
M10 X 1.25	10.30	11.62 - 11.89	11.45 - 12.65
M10 x 1.00	10.30	11.30 - 11.51	11.17 - 12.50
M11 X 1.50	11.40	12.95 - 13.27	12.74 - 13.59
M11 X 1.25	11.30	12.62 - 12.89	12.47 - 13.76
M12 X 1.75	12.50	14.27 - 14.65	14.03 - 15.00
M12 X 1.50	12.40	13.95 - 14.27	13.75 - 15.20
M12 X 1.25	12.30	13.62 - 13.89	13.47 - 15.00
M14 X 2.00	14.50	16.60 - 17.03	16.31 - 17.35
M14 X 1.50	14.40	15.95 - 16.27	15.75 - 17.25
M14 X 1.25	14.30	15.62 - 15.89	15.47 - 17.03
M16 X 2.00	16.50	18.60 - 19.03	18.31 - 19.60
M16 X 1.50	16.50	17.95 - 18.27	17.75 - 19.60
M18 X 2.50	18.80	21.25 - 21.79	20.86 - 22.00
M18 X 2.00	18.50	20.60 - 21.03	20.31 - 21.85
M20 X 2.50	20.80	23.25 - 23.79	22.86 - 24.40
M20 X 2.00	20.50	22.60 - 23.03	22.31 - 24.05
M20 X 1.50	20.50	21.95 - 22.27	21.75 - 24.00
M22 X 2.50	22.80	25.25 - 25.79	24.86 - 26.90
M22 X 2.00	22.50	24.60 - 25.03	24.31 - 26.50
M22 X 1.50	22.50	23.95 - 24.27	23.75 - 26.45
M24 X 3.00	25.00	27.90 - 28.54	27.43 - 29.00
M24 X 2.00	24.50	26.60 - 27.03	26.32 - 29.10
M27 X 3.00	28.00	30.90 - 31.54	30.43 - 32.40
M27 X 2.00	27.50	29.60 - 30.03	29.32 - 32.30
M30 X 3.50	31.00	34.55 - 35.30	33.99 - 35.81
M30 X 3.00	31.00	33.90 - 34.54	33.43 - 36.10
M33 X 3.50	34.00	37.55 - 38.30	36.99 - 38.80
M36 X 4.00	37.00	41.20 - 42.06	40.54 - 42.67
M36 X 3.00	37.00	39.90 - 40.54	39.43 - 42.70
M39 X 4.00	40.00	44.20 - 45.06	43.54 - 45.75
M42 X 4.50	43.00	47.85 - 48.82	47.10 - 49.00
M42 X 3.00	42.50	45.90 - 46.54	45.43 - 49.00

NC (Number of Free Coils)				
1.0D	1.5D	2.0D	2.5D	3.0D
3.00 - 3.30	5.20 - 5.70	7.40 - 8.10	9.60 - 10.50	11.80 - 13.00
3.10 - 3.80	5.20 - 6.50	7.40 - 9.20	9.50 - 11.90	11.70 - 14.60
3.40 - 4.30	5.80 - 7.20	8.20 - 10.10	10.50 - 13.10	12.90 - 16.00
3.40 - 4.10	5.80 - 7.00	8.20 - 9.80	10.50 - 12.60	12.90 - 15.50
3.40 - 4.00	5.70 - 6.80	8.10 - 9.60	10.50 - 12.30	12.80 - 15.10
3.90 - 4.50	6.50 - 7.60	9.20 - 10.60	11.80 - 13.70	14.40 - 16.70
3.80 - 4.30	6.40 - 7.20	9.10 - 10.1	11.70 - 13.10	14.30 - 16.00
4.60 - 5.30	7.70 - 8.70	10.70 - 12.10	13.70 - 15.60	16.70 - 19.00
4.20 - 4.70	7.10 - 7.80	9.90 - 10.90	12.80 - 14.10	15.60 - 17.20
5.60 - 6.10	9.10 - 10.00	12.50 - 13.80	16.00 - 17.70	19.50 - 21.50
5.10 - 5.50	8.40 - 9.00	11.70 - 12.50	15.00 - 16.10	18.30 - 19.60
6.50 - 7.10	10.50 - 11.50	14.50 - 15.80	18.50 - 20.20	22.50 - 24.50
4.60 - 4.90	7.70 - 8.20	10.80 - 11.50	13.80 - 14.70	16.90 - 18.00
5.60 - 6.10	9.20 - 10.00	12.70 - 13.80	16.30 - 17.70	19.80 - 21.50
7.30 - 8.10	11.70 - 12.90	16.10 - 17.80	20.50 - 22.60	24.90 - 27.50
5.20 - 5.60	8.60 - 9.20	12.00 - 12.80	15.40 - 16.40	18.70 - 20.00
6.40 - 6.90	10.30 - 11.20	14.20 - 15.40	18.10 - 19.70	22.00 - 23.90
4.80 - 5.10	7.90 - 8.50	11.10 - 11.90	14.20 - 15.20	17.30 - 18.60
5.60 - 6.10	9.20 - 10.00	12.70 - 13.80	16.20 - 17.70	19.80 - 21.50
7.00 - 7.70	11.20 - 12.40	15.50 - 17.00	19.70 - 21.60	23.90 - 26.30
5.00 - 5.30	8.20 - 8.70	11.40 - 12.10	14.60 - 15.60	17.90 - 19.00
6.90 - 7.50	11.10 - 12.00	15.30 - 16.50	19.40 - 21.00	23.60 - 25.50
8.60 - 9.30	13.60 - 14.70	18.60 - 20.20	23.60 - 25.60	28.60 - 31.00
5.90 - 6.30	9.50 - 10.20	13.20 - 14.20	16.90 - 18.10	20.50 - 22.00
8.00 - 8.80	12.80 - 13.90	17.50 - 19.10	22.30 - 24.30	27.00 - 29.40
5.20 - 5.50	8.60 - 9.00	11.90 - 12.50	15.30 - 16.10	18.60 - 19.60
6.70 - 7.10	10.90 - 11.50	15.00 - 15.80	19.10 - 20.20	23.20 - 24.50
5.90 - 6.30	9.60 - 10.20	13.30 - 14.20	16.90 - 18.10	20.60 - 22.00
7.70 - 8.10	12.20 - 12.90	16.80 - 17.80	21.40 - 22.60	25.90 - 27.50
10.50 - 11.40	16.40 - 17.90	22.40 - 24.40	28.30 - 30.90	34.30 - 37.40
6.50 - 7.10	10.50 - 11.40	14.50 - 15.80	18.50 - 20.10	22.50 - 24.50
8.50 - 9.10	13.40 - 14.40	18.40 - 19.80	23.40 - 25.10	28.40 - 30.40
11.60 - 12.70	18.10 - 19.90	24.60 - 27.00	31.10 - 34.20	37.60 - 41.30
5.90 - 6.30	9.70 - 10.20	13.40 - 14.20	17.10 - 18.10	20.90 - 22.00
9.20 - 10.10	14.60 - 15.90	19.90 - 21.70	25.30 - 27.60	30.60 - 33.40
6.80 - 7.30	11.00 - 11.70	15.20 - 16.20	19.30 - 20.60	23.50 - 25.10
10.60 - 11.60	16.70 - 18.10	22.70 - 24.70	28.80 - 31.30	34.80 - 37.90
6.50 - 6.90	10.50 - 11.10	14.50 - 15.30	18.60 - 19.50	22.60 - 23.80
7.60 - 8.10	12.20 - 12.90	16.80 - 17.80	21.30 - 22.60	25.90 - 27.50
7.40 - 7.70	11.80 - 12.40	16.20 - 17.00	20.70 - 21.70	25.10 - 26.40
6.90 - 7.30	11.20 - 11.70	15.40 - 16.20	19.60 - 20.60	23.80 - 25.10
9.50 - 10.10	14.90 - 15.90	20.40 - 21.70	25.90 - 27.60	31.40 - 33.40
7.70 - 8.00	12.20 - 12.90	16.80 - 17.70	21.40 - 22.50	26.00 - 27.30
7.30 - 7.60	11.80 - 12.20	16.20 - 16.80	20.70 - 21.50	25.10 - 26.10
11.40 - 12.10	17.80 - 18.90	24.20 - 25.70	30.60 - 32.50	37.10 - 39.30

## ISO Metric

As with all engineering practice, the success of any drilling & tapping operation is dependant upon many factors, i.e. the type of material being cut : style of tap : cutting speed / feed : coolant type etc. Due to the vast range of parent material now available to the engineer it is not possible to make specific recommendations. However when using Wire Thread Inserts it is important that the charted sizes for diameter & length are achieved and the necessary fit class exists in the tapped hole.

**Note 1:**  
The minimum drilling depth for blind holes (AL) is equal to the nominal length of insert + 5 thread pitches where finishing taps are used or nominal length of insert + 3 thread pitches where bottoming or spiral flute taps are used. eg. for M6 (1.0) x 1 dia long (using finishing taps) :- 6mm + 5mm = 11mm

**Note 2:**  
The minimum tapping depth to full thread (BL) is equal to the nominal length of insert + 1 thread pitch. eg. for M6 (1.0) x 1 dia long :- 6mm + 1mm = 7mm

**Note 3:**  
For optimum thread performance, wire thread inserts must be installed 1/2 to 1 full thread pitches below the top surface of the tapped hole. For this reason, the actual length of any installed insert is equal to the nominal specified length less 1/2 to 1 full thread pitch.

# UNF

## Threads to:-

- |          |             |
|----------|-------------|
| BS1580   | SAE 8879    |
| BSA346   | FED-STD-H28 |
| ISO 5864 | ASME B1.1   |
| ISO 3161 | ASME B1.15  |

Free diameter values and number of free coils are for guidance purposes only.

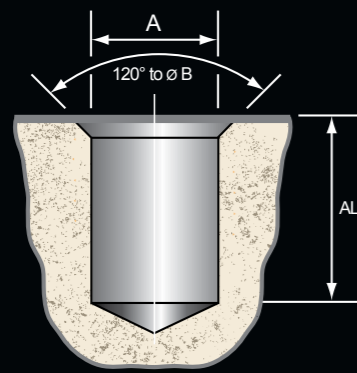

**DRILLED HOLE**  
See Note 1 opposite

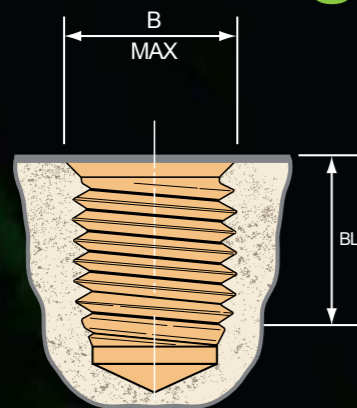

**TAPPED HOLE**  
See Note 2 opposite

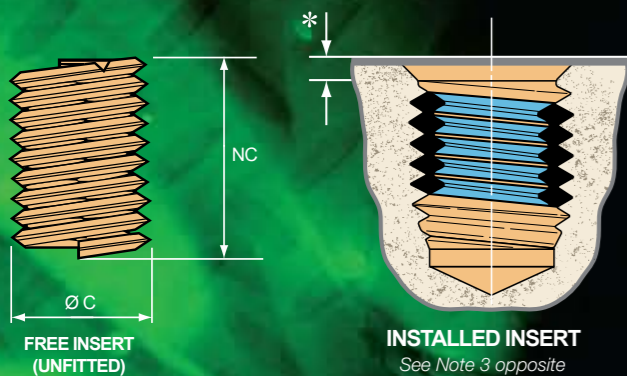

**INSTALLED INSERT**  
See Note 3 opposite

SIZE	Drill	B	Free Coil ØC
inch	mm	inch	inch
2-64	2.30	0.106 - 0.110	0.105 - 0.116
3-56	2.70	0.122 - 0.126	0.120 - 0.146
4-48	3.00	0.139 - 0.144	0.137 - 0.162
5-44	3.40	0.154 - 0.159	0.152 - 0.168
6-40	3.70	0.170 - 0.176	0.168 - 0.193
8-36	4.40	0.200 - 0.206	0.197 - 0.224
10-32	5.10	0.231 - 0.273	0.227 - 0.256
1/4-28	6.60	0.296 - 0.304	0.292 - 0.326
5/16-24	8.20	0.367 - 0.376	0.361 - 0.400
3/8-24	9.80	0.429 - 0.438	0.424 - 0.468
7/16-20	11.50	0.502 - 0.513	0.496 - 0.549
1/2-20	13.00	0.565 - 0.576	0.559 - 0.617
9/16-18	14.70	0.635 - 0.647	0.628 - 0.691
5/8-18	16.30	0.697 - 0.709	0.690 - 0.758
3/4-16	19.50	0.831 - 0.845	0.823 - 0.901
7/8-14	22.50	0.968 - 0.983	0.958 - 1.051
1"-12	26.00	1.108 - 1.126	1.097 - 1.199
1"1/8-12	29.50	1.233 - 1.251	1.222 - 1.334
1"1/4-12	32.50	1.358 - 1.376	1.347 - 1.469
1"3/8-12	35.50	1.483 - 1.501	1.472 - 1.610
1"1/2-12	38.50	1.608 - 1.626	1.598 - 1.745

SIZE	Drill	B	Free Coil ØC
inch	mm	inch	Inch
2-56	2.40	0.109 - 0.113	0.107 - 0.119
3-48	2.70	0.126 - 0.131	0.124 - 0.139
4-40	3.00	0.144 - 0.1510	0.142 - 0.159
5-40	3.40	0.157 - 0.163	0.155 - 0.173
6-32	3.70	0.179 - 0.185	0.175 - 0.193
8-32	4.40	0.205 - 0.211	0.201 - 0.220
10-24	5.10	0.244 - 0.253	0.238 - 0.259
12-24	5.70	0.270 - 0.279	0.265 - 0.283
1/4-20	6.70	0.315 - 0.326	0.308 - 0.330
5/16-18	8.30	0.385 - 0.397	0.377 - 0.400
3/8-16	9.90	0.456 - 0.470	0.447 - 0.472
7/16-14	11.60	0.530 - 0.546	0.520 - 0.551
1/2-13	13.00	0.600 - 0.616	0.588 - 0.622
9/16-12	15.00	0.671 - 0.689	0.659 - 0.694
5/8-11	16.50	0.743 - 0.763	0.730 - 0.767
3/4-10	19.80	0.880 - 0.901	0.865 - 0.906
7/8-9	23.00	1.019 - 1.043	1.002 - 1.052
1"-8	26.20	1.162 - 1.189	1.143 - 1.196
1"1/8-7	29.50	1.311 - 1.341	1.288 - 1.355
1"1/4-7	32.50	1.436 - 1.466	1.413 - 1.483
1"3/8-6	36.00	1.591 - 1.627	1.565 - 1.643
1"1/2-6	39.50	1.716 - 1.752	1.690 - 1.772

NC (Number of Free Coils)				
1.0D	1.5D	2.0D	2.5D	3.0D
3.40 - 3.70	5.80 - 6.30	8.20 - 8.90	10.50 - 11.60	12.90 - 14.20
3.10 - 3.70	5.20 - 6.40	7.40 - 9.00	9.60 - 11.60	11.80 - 14.30
3.20 - 3.70	5.40 - 6.40	7.60 - 9.00	9.80 - 11.60	12.10 - 14.20
3.40 - 3.70	5.80 - 6.30	8.20 - 8.90	10.60 - 11.50	13.00 - 14.20
3.20 - 3.70	5.50 - 6.30	7.80 - 9.00	10.10 - 11.60	12.40 - 14.20
3.60 - 4.10	6.10 - 6.90	8.60 - 9.70	11.10 - 12.50	13.60 - 15.30
3.80 - 4.30	6.40 - 7.20	9.00 - 10.10	11.60 - 13.00	14.20 - 15.90
4.70 - 5.20	7.70 - 8.50	10.80 - 11.90	13.80 - 15.20	16.90 - 18.60
5.10 - 5.60	8.50 - 9.20	11.70 - 12.80	15.00 - 16.40	18.30 - 20.00
6.50 - 7.10	10.50 - 11.40	14.50 - 15.80	18.50 - 20.10	22.50 - 24.50
6.30 - 6.90	10.20 - 11.10	14.00 - 15.30	17.90 - 19.50	21.70 - 23.70
7.40 - 8.10	11.90 - 12.90	16.30 - 17.80	20.80 - 22.60	25.20 - 27.50
7.60 - 8.30	12.20 - 13.30	16.80 - 18.20	21.30 - 23.10	25.90 - 28.10
8.70 - 9.40	13.80 - 14.90	18.90 - 20.50	24.00 - 26.00	29.10 - 31.50
9.30 - 10.10	14.70 - 15.90	20.10 - 21.70	25.50 - 27.60	30.90 - 33.40
9.60 - 10.30	15.10 - 16.30	20.60 - 22.20	26.10 - 28.20	31.60 - 34.20
9.40 - 10.10	14.80 - 16.00	20.30 - 21.80	25.70 - 27.70	31.10 - 33.50
10.80 - 11.60	16.90 - 18.20	23.00 - 24.80	29.20 - 31.40	35.30 - 38.00
13.10 - 12.20	19.00 - 20.40	25.80 - 27.80	32.70 - 35.10	39.50 - 42.50
14.60 - 13.50	21.00 - 22.70	28.50 - 30.80	36.00 - 38.80	43.50 - 46.90
16.10 - 14.90	23.10 - 24.90	31.30 - 33.70	39.50 - 42.60	47.70 - 51.40

NC (Number of Free Coils)				
1.0D	1.5D	2.0D	2.5D	3.0D
2.80 - 3.10	4.80 - 5.40	6.90 - 7.80	9.00 - 10.10	11.10 - 12.50
2.80 - 3.20	4.90 - 5.50	7.00 - 7.90	9.00 - 10.30	11.20 - 12.70
2.40 - 2.80	4.30 - 4.90	6.20 - 7.10	8.10 - 9.20	10.00 - 11.40
2.90 - 3.30	5.00 - 5.70	7.20 - 8.10	9.30 - 10.50	11.50 - 13.00
2.40 - 2.70	4.30 - 4.80	6.20 - 7.00	8.20 - 9.10	10.10 - 11.20
3.20 - 3.50	5.50 - 6.10	7.80 - 8.60	10.10 - 11.20	12.40 - 13.70
2.60 - 2.80	4.60 - 5.00	6.70 - 7.20	8.70 - 9.40	10.70 - 11.60
3.20 - 3.50	5.60 - 6.00	7.90 - 8.50	10.30 - 11.00	12.60 - 13.50
3.10 - 3.30	5.30 - 5.70	7.60 - 8.10	9.90 - 10.50	12.10 - 13.00
3.70 - 3.90	6.30 - 6.70	8.90 - 9.50	11.50 - 12.20	14.10 - 15.00
4.10 - 4.30	6.80 - 7.20	9.60 - 10.10	12.40 - 13.10	15.20 - 16.00
4.10 - 4.40	7.00 - 7.40	9.80 - 10.40	12.60 - 13.40	15.50 - 16.30
4.50 - 4.80	7.50 - 8.00	10.60 - 11.10	13.60 - 14.30	16.60 - 17.50
4.80 - 5.00	7.90 - 8.40	11.10 - 11.70	14.20 - 15.00	17.40 - 18.30
4.90 - 5.10	8.10 - 8.50	11.30 - 11.90	14.50 - 15.20	17.70 - 18.60
5.50 - 5.80	9.00 - 9.50	12.60 - 13.10	16.10 - 16.80	19.60 - 20.50
5.90 - 6.20	9.60 - 10.00	13.30 - 13.90	17.00 - 17.80	20.70 - 21.70
6.00 - 6.30	9.80 - 10.20	13.60 - 14.20	17.30 - 18.10	21.10 - 22.00
5.90 - 6.20	9.60 - 10.10	13.30 - 14.00	17.00 - 17.90	20.70 - 21.80
6.70 - 7.10	10.90 - 11.40	15.00 - 15.80	19.20 - 20.10	23.30 - 24.40
6.20 - 6.50	10.10 - 10.60	14.00 - 14.60	17.80 - 18.70	21.70 - 22.70
6.90 - 7.30	11.20 - 11.70	15.40 - 16.10	19.60 - 20.60	23.90 - 25.00

## UNF & UNC

As with all engineering practice, the success of any drilling & tapping operation is dependant upon many factors, i.e. the type of material being cut : style of tap : cutting speed / feed : coolant type etc. Due to the vast range of parent material now available to the engineer it is not possible to make specific recommendations. However when using Wire Thread Inserts it is important that the charted sizes for diameter & length are achieved and the necessary fit class exists in the tapped hole.

**Note 1:**  
The minimum drilling depth for blind holes (AL) is equal to the nominal length of insert + 5 thread pitches where finishing taps are used or nominal length of insert + 3 thread pitches where bottoming or spiral flute taps are used. eg. for M6 (1.0) x 1 dia long (using finishing taps) :- 6mm + 5mm = 11mm

**Note 2:**  
The minimum tapping depth to full thread (BL) is equal to the nominal length of insert + 1 thread pitch. eg. for M6 (1.0) x 1 dia long :- 6mm + 1mm = 7mm

**Note 3:**  
For optimum thread performance, wire thread inserts must be installed 1/2 to 1 full thread pitches below the top surface of the tapped hole. For this reason, the actual length of any installed insert is equal to the nominal specified length less 1/2 to 1 full thread pitch.

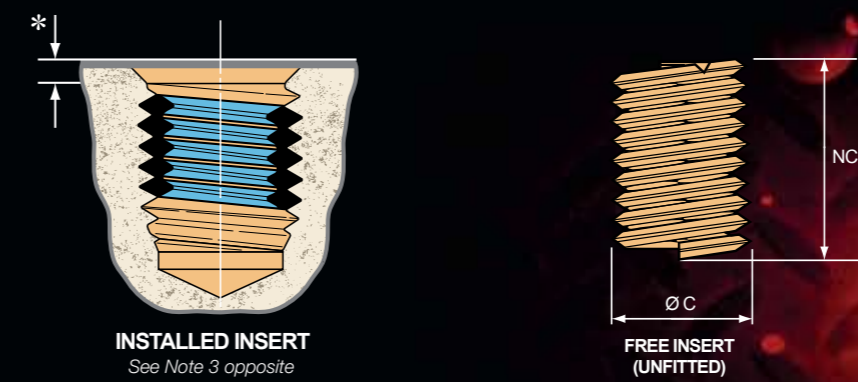
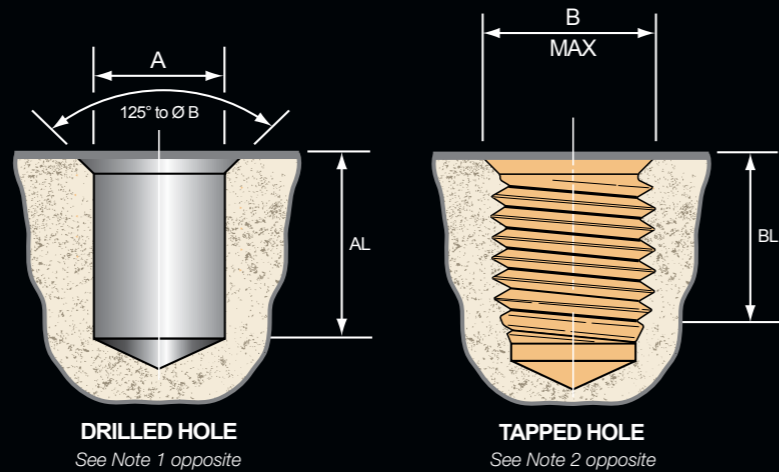

## BSF

Threads to:-  
BS 84

Free diameter values and number of free coils are for guidance purposes only.

SIZE	Drill	B	Free Coil ØC
inch	mm	inch	Inch
3/16-32	5.00	0.225 - 0.237	0.225 - 0.247
1/4-26	6.60	0.296 - 0.311	0.296 - 0.331
5/16-22	8.30	0.366 - 0.385	0.367 - 0.405
3/8-20	9.80	0.434 - 0.455	0.435 - 0.476
7/16-18	11.60	0.503 - 0.526	0.504 - 0.555
1/2-16	13.20	0.574 - 0.600	0.575 - 0.630
9/16-16	14.80	0.636 - 0.662	0.637 - 0.700
5/8-14	16.30	0.709 - 0.739	0.710 - 0.775
3/4-12	19.50	0.848 - 0.883	0.849 - 0.925
7/8-11	22.80	0.982 - 1.020	0.983 - 1.074
1"-10	26.20	1.117 - 1.160	1.119 - 1.220
1"1/8-9	29.50	1.255 - 1.303	1.257 - 1.366
1"1/4-9	32.50	1.380 - 1.428	1.382 - 1.500
1"3/8-8	36.00	1.521 - 1.575	1.523 - 1.657
1"1/2-8	39.00	1.646 - 1.700	1.648 - 1.811

NC (Number of Free Coils)				
1.0D	1.5D	2.0D	2.5D	3.0D
3.90 - 4.30	6.50 - 7.20	9.20 - 10.20	11.90 - 13.10	14.50 - 16.00
4.30 - 4.80	7.10 - 7.90	9.90 - 11.20	12.70 - 14.40	15.60 - 17.50
4.70 - 5.20	7.70 - 8.50	10.70 - 11.90	13.80 - 15.30	16.80 - 18.70
5.30 - 5.80	8.60 - 9.40	12.00 - 13.20	15.30 - 16.90	18.70 - 20.50
5.60 - 6.20	9.10 - 10.00	12.60 - 13.90	16.10 - 17.80	19.60 - 21.60
5.70 - 6.30	9.30 - 10.20	12.90 - 14.20	16.50 - 18.10	20.00 - 22.00
6.60 - 7.30	10.60 - 11.70	14.70 - 16.10	18.70 - 20.60	22.70 - 25.00
6.50 - 7.10	10.40 - 11.30	14.30 - 15.70	18.30 - 20.00	22.20 - 24.30
6.70 - 7.30	10.80 - 11.70	14.90 - 16.20	19.00 - 20.70	23.00 - 25.10
7.20 - 7.90	11.60 - 12.60	15.90 - 17.40	20.30 - 22.10	24.60 - 26.90
7.60 - 8.30	12.10 - 13.20	16.60 - 18.10	21.20 - 23.10	25.70 - 28.00
7.80 - 8.40	12.30 - 13.30	17.00 - 18.40	21.50 - 23.40	26.10 - 28.40
8.80 - 9.50	13.90 - 15.00	19.00 - 20.60	24.20 - 26.20	29.30 - 31.70
8.50 - 9.30	13.50 - 14.60	18.50 - 20.10	23.50 - 25.50	28.50 - 31.00
9.40 - 10.30	14.80 - 16.10	20.10 - 22.10	25.50 - 28.00	30.90 - 33.90

BSF & BSW

BSF & BSW

## BSW

SIZE	Drill	B	Free Coil ØC
inch	mm	inch	
1/8-40	3.40	0.155 - 0.165	0.155 - 0.173
3/16-24	5.00	0.236 - 0.254	0.237 - 0.256
1/4-20	6.70	0.309 - 0.330	0.309 - 0.331
5/16-18	8.30	0.378 - 0.401	0.378 - 0.401
3/8-16	10.00	0.448 - 0.475	0.449 - 0.472
7/16-14	11.60	0.521 - 0.552	0.522 - 0.551
1/2-12	13.00	0.597 - 0.633	0.598 - 0.630
9/16-12	14.80	0.660 - 0.696	0.661 - 0.694
5/8-11	16.70	0.731 - 0.770	0.732 - 0.767
3/4-10	20.00	0.867 - 0.910	0.868 - 0.905
7/8-9	23.20	1.005 - 1.053	1.006 - 1.051
1"-8	26.50	1.146 - 1.200	1.147 - 1.197
1"1/8-7	30.00	1.291 - 1.354	1.293 - 1.354
1"1/4-7	33.00	1.416 - 1.479	1.418 - 1.484
1"1/2-6	39.50	1.694 - 1.767	1.696 - 1.776

NC (Number of Free Coils)				
1.0D	1.5D	2.0D	2.5D	3.0D
3.00 - 3.40	5.10 - 5.80	7.30 - 8.40	9.40 - 10.90	11.60 - 13.40
2.60 - 2.90	4.60 - 5.10	6.60 - 7.40	8.70 - 9.70	10.70 - 11.90
3.10 - 3.40	5.40 - 5.90	7.70 - 8.50	9.90 - 11.00	12.20 - 13.50
3.80 - 4.10	6.40 - 6.90	9.00 - 9.80	11.60 - 12.60	14.20 - 15.50
4.10 - 4.40	6.90 - 7.40	9.70 - 10.50	12.50 - 13.50	15.30 - 16.50
4.20 - 4.60	7.10 - 7.60	9.90 - 10.70	12.80 - 13.80	15.60 - 16.90
4.10 - 4.50	7.00 - 7.40	9.80 - 10.50	12.60 - 13.60	15.40 - 16.60
4.90 - 5.20	8.00 - 8.60	11.20 - 12.00	14.40 - 15.40	17.60 - 18.80
5.00 - 5.30	8.20 - 8.70	11.50 - 12.20	14.70 - 15.70	17.90 - 19.20
5.60 - 6.00	9.20 - 9.70	12.70 - 13.50	16.30 - 17.30	19.80 - 21.10
6.00 - 6.30	9.70 - 10.20	13.40 - 14.30	17.10 - 18.20	20.90 - 22.20
6.10 - 6.50	9.90 - 10.40	13.70 - 14.50	17.50 - 18.60	21.20 - 22.60
5.90 - 6.30	9.60 - 10.20	13.40 - 14.30	17.10 - 18.20	20.80 - 22.20
6.80 - 7.20	10.90 - 11.60	15.00 - 16.00	19.20 - 20.40	23.30 - 24.90
7.00 - 7.50	11.30 - 11.90	15.50 - 16.50	19.80 - 21.10	24.00 - 25.60

As with all engineering practice, the success of any drilling & tapping operation is dependant upon many factors, i.e. the type of material being cut : style of tap : cutting speed / feed : coolant type etc. Due to the vast range of parent material now available to the engineer it is not possible to make specific recommendations. However when using Wire Thread Inserts it is important that the charted sizes for diameter & length are achieved and the necessary fit class exists in the tapped hole.

**Note 1:**  
The minimum drilling depth for blind holes (AL) is equal to the nominal length of insert + 5 thread pitches where finishing taps are used or nominal length of insert + 3 thread pitches where bottoming or spiral flute taps are used. eg. for M6 (1.0) x 1 dia long (using finishing taps) :- 6mm + 5mm = 11mm

**Note 2:**  
The minimum tapping depth to full thread (BL) is equal to the nominal length of insert + 1 thread pitch. eg. for M6 (1.0) x 1 dia long :- 6mm + 1mm = 7mm

**Note 3:**  
For optimum thread performance, wire thread inserts must be installed 1/2 to 1 full thread pitches below the top surface of the tapped hole. For this reason, the actual length of any installed insert is equal to the nominal specified length less 1/2 to 1 full thread pitch.

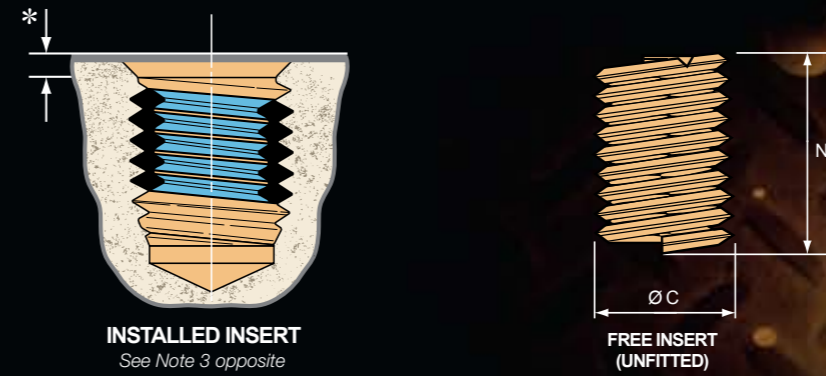
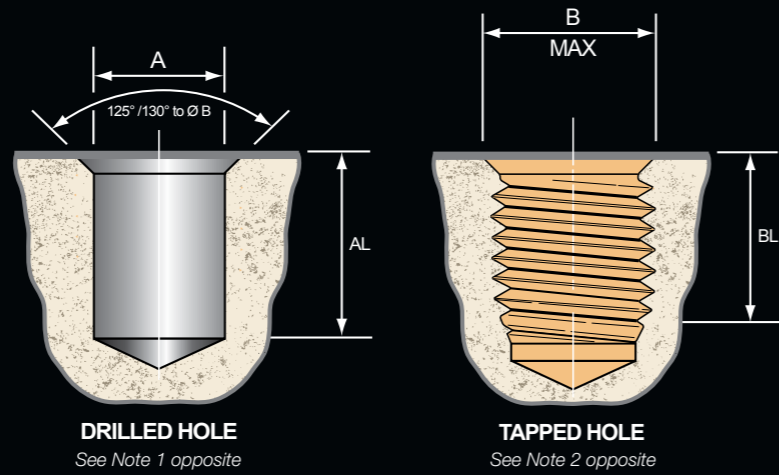

## BSP

### Threads to:-

BS EN ISO 228-1  
BS EN ISO 226-1

Free diameter values and number of free coils are for guidance purposes only.

SIZE	Drill	B	Free Coil ØC
inch	mm	inch	
1/8-28	10.00	0.426 - 0.440	0.426 - 0.472
1/4-19	13.60	0.580 - 0.602	0.582 - 0.637
3/8-19	17.10	0.718 - 0.735	0.720 - 0.787
1/2-14	21.50	0.909 - 0.939	0.911 - 0.992
5/8-14	23.40	0.986 - 1.016	0.988 - 1.078
3/4-14	27.00	1.125 - 1.155	1.127 - 1.228
7/8-14	30.50	1.273 - 1.303	1.275 - 1.389
1"-11	33.70	1.416 - 1.454	1.416 - 1.543
1"1/4-11	42.50	1.757 - 1.795	1.759 - 1.909
1"1/2-11	48.50	1.989 - 2.027	1.991 - 2.161

NC (Number of Free Coils)				
1.0D	1.5D	2.0D	2.5D	3.0D
1.70 - 1.90	3.20 - 3.60	4.80 - 5.30	6.40 - 7.00	7.90 - 8.80
2.80 - 3.10	5.00 - 5.40	7.10 - 7.80	9.20 - 10.10	11.40 - 12.50
5.00 - 5.50	8.20 - 8.90	11.40 - 12.50	14.60 - 16.00	17.90 - 19.50
4.90 - 5.30	8.10 - 8.80	11.20 - 12.20	14.40 - 15.70	17.60 - 19.10
6.50 - 7.10	10.40 - 11.30	14.40 - 15.70	18.40 - 20.00	22.30 - 24.30
8.10 - 8.80	12.90 - 13.90	17.60 - 19.20	22.40 - 24.30	27.20 - 29.50
9.70 - 10.50	15.30 - 16.50	20.80 - 22.60	26.40 - 28.70	32.00 - 34.70
8.60 - 9.30	13.60 - 14.70	18.60 - 20.10	23.60 - 25.60	28.60 - 31.00
11.10 - 12.00	17.40 - 18.70	23.70 - 25.60	30.00 - 32.40	36.20 - 39.20
13.60 - 14.70	21.20 - 22.80	28.70 - 31.00	36.30 - 39.20	43.80 - 47.30

BSP & BA

BSP & BA

## BA

### Threads to:-

BS 93

SIZE	Drill	B	Free Coil ØC
	mm	inch	
6BA	2.90	0.134 - 0.146	0.133 - 0.147
5BA	3.40	0.152 - 0.169	0.152 - 0.167
4BA	3.80	0.171 - 0.190	0.170 - 0.188
3BA	4.30	0.194 - 0.215	0.193 - 0.213
2BA	4.90	0.221 - 0.244	0.220 - 0.243
1BA	5.50	0.248 - 0.274	0.248 - 0.273
0BA	6.20	0.280 - 0.309	0.280 - 0.309

NC (Number of Free Coils)				
1.0D	1.5D	2.0D	2.5D	3.0D
3.30 - 3.60	5.60 - 6.20	7.90 - 8.70	10.20 - 11.20	12.50 - 13.80
3.40 - 3.80	5.80 - 6.40	8.10 - 9.00	10.50 - 11.60	12.90 - 14.20
3.50 - 3.80	5.80 - 6.40	8.20 - 9.10	10.60 - 11.70	13.00 - 14.40
3.60 - 3.90	6.00 - 6.70	8.50 - 9.40	10.90 - 12.10	13.40 - 14.80
3.80 - 4.20	6.30 - 6.90	8.80 - 9.80	11.40 - 12.60	13.90 - 15.40
3.80 - 4.20	6.40 - 7.10	9.00 - 9.90	11.60 - 12.80	14.10 - 15.60
3.90 - 4.30	6.60 - 7.20	9.20 - 10.10	11.80 - 13.00	14.50 - 16.00

As with all engineering practice, the success of any drilling & tapping operation is dependant upon many factors, i.e. the type of material being cut, style of tap, cutting speed / feed, coolant type etc. Due to the vast range of parent material now available to the engineer it is not possible to make specific recommendations. However when using Wire Thread Inserts it is important that the charted sizes for diameter & length are achieved and the necessary fit class exists in the tapped hole.

**Note 1:**  
The minimum drilling depth for blind holes (AL) is equal to the nominal length of insert + 5 thread pitches where finishing taps are used or nominal length of insert + 3 thread pitches where bottoming or spiral flute taps are used, eg. for M6 (1.0) x 1 dia long (using finishing taps) :- 6mm + 5mm = 11mm

**Note 2:**  
The minimum tapping depth to full thread (BL) is equal to the nominal length of insert + 1 thread pitch, eg. for M6 (1.0) x 1 dia long :- 6mm + 1mm = 7mm

**Note 3:**  
For optimum thread performance, wire thread inserts must be installed 1/2 to 1 full thread pitches below the top surface of the tapped hole. For this reason, the actual length of any installed insert is equal to the nominal specified length less 1/2 to 1 full thread pitch.





WTI Fasteners Ltd  
Unit 7, Marquis Court, Rawdon Business Park,  
Moir, Derbyshire DE12 6EJ

Tel: 01283 215588 | Fax: 01283 212020  
Email: [info@wireinserts.com](mailto:info@wireinserts.com) | Web: [www.wireinserts.com](http://www.wireinserts.com)



FM28879